

Note: This printed circuit board diagram may be modified at any time with the development of new technology.

A TUNER P.C.B.

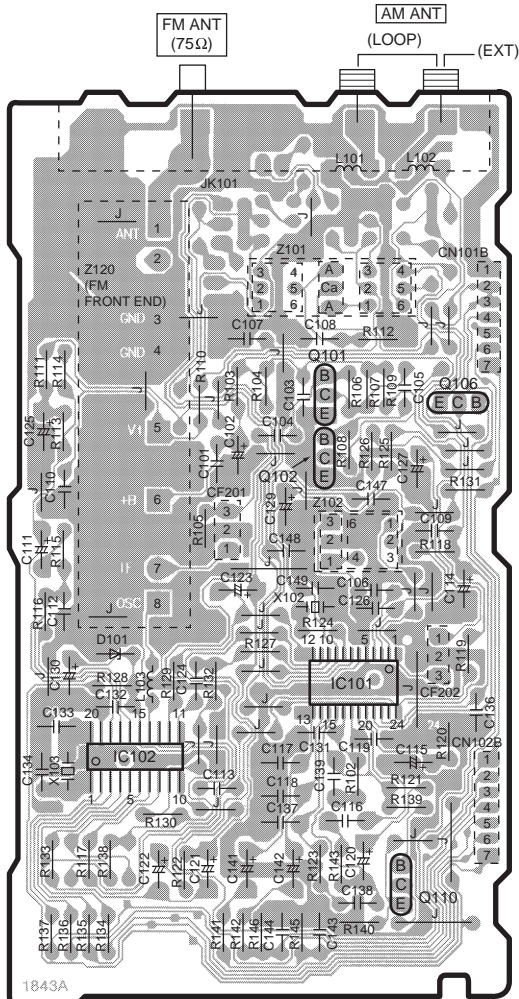

[Keeping to the rule of unit supply, we do not supply single parts.]

D LED(L) P.C.B.

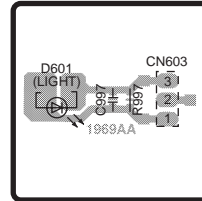

E LED(R) P.C.B.

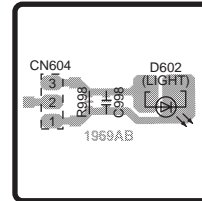

ELECTRICAL PARTS LOCATION

Ref. No.	Lo. No.	Ref. No.	Lo. No.
A TUNER P.C.B.			
IC101	4B	R136	5A
IC102	5A	R137	5A
Q101	3B	R138	5A
Q102	3B	R139	5C
Q106	3C	R140	5B
Q110	5C	R141	5B
D101	4A	R142	5B
L101	2B	R143	5B
L102	2C	R145	5B
L103	4A	R146	5B
Z101	3B	C101	3B
Z102	4B	C102	3B
Z120	3A	C103	3B
CF201	4B	C104	3B
CF202	4C	C105	3C
X102	4B	C106	4B
X103	5A	C107	3B
CN101B	3C	C108	3B
CN102B	5C	C109	4C
JK101	2B	C110	3A
R102	5B	C111	4A
R103	3B	C112	4A
R104	3B	C113	5B
R105	4B	C114	4C
R106	3B	C115	5C
R107	3B	C116	5B
R108	3B	C117	5B
R109	3C	C118	5B
R110	3B	C119	5B
R111	3A	C120	5B
R112	3C	C121	5B
R113	3A	C122	5A
R114	3A	C123	4B
R115	4A	C124	4B
R116	4A	C125	3A
R117	5A	C126	4B
R118	4C	C127	3C
R119	4C	C129	4B
R120	5C	C130	4A
R121	5C	C131	5B
R122	5B	C132	4A
R123	5B	C133	5A
R124	4B	C134	5A
R125	3C	C136	4C
R126	3B	C137	5B
R127	4B	C138	5B
R128	4A	C139	5B
R129	4B	C141	5B
R130	5B	C142	5B
R131	3C	C143	5B
R132	4B	C144	5B
R133	5A	C147	4B
R134	5A	C148	4B
R135	5A	C149	4B
D LED(L) P.C.B.			
D601	2D	R997	2D
CN603	2D	C997	2D
E LED(R) P.C.B.			
D602	4D	R998	4D
CN604	4D	C998	4D
F IN/OUT TERMINAL P.C.B.			
CN105B	8B	R208	7C
JK201	7C	C201	7C
R201	8C	C202	7C
R202	7C	C203	7C
R203	8C	C204	7C
R204	7C	C205	7C
R205	7C	C206	7C
R206	7C	C209	7C
R207	7C		

F IN/OUT TERMINAL P.C.B.

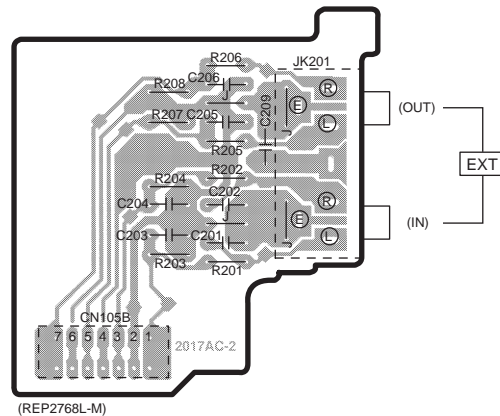

B FL P.C.B.

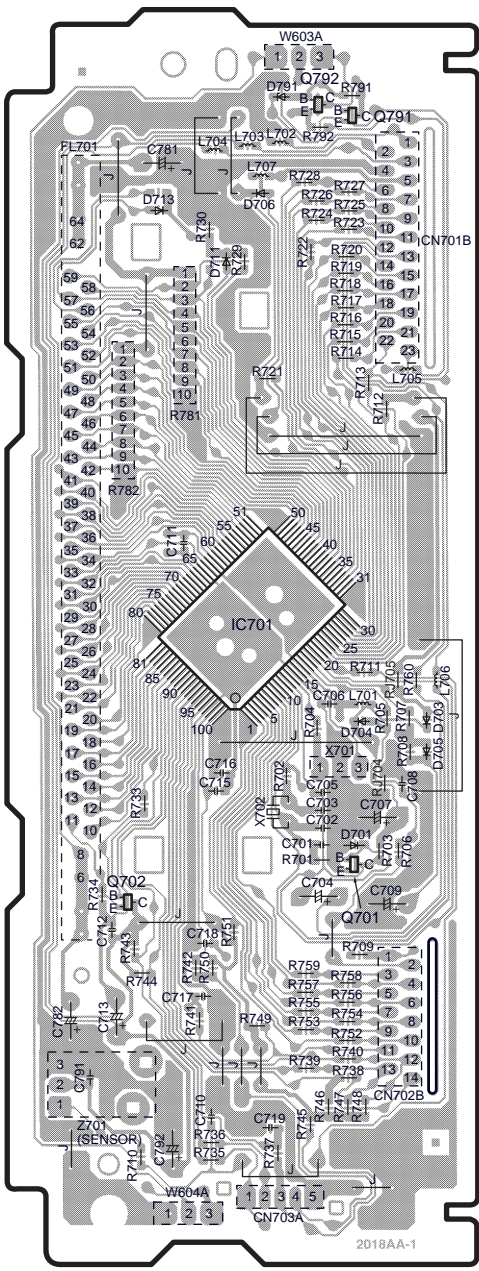

(REP2769G-S)

C OPERATION P.C.B.

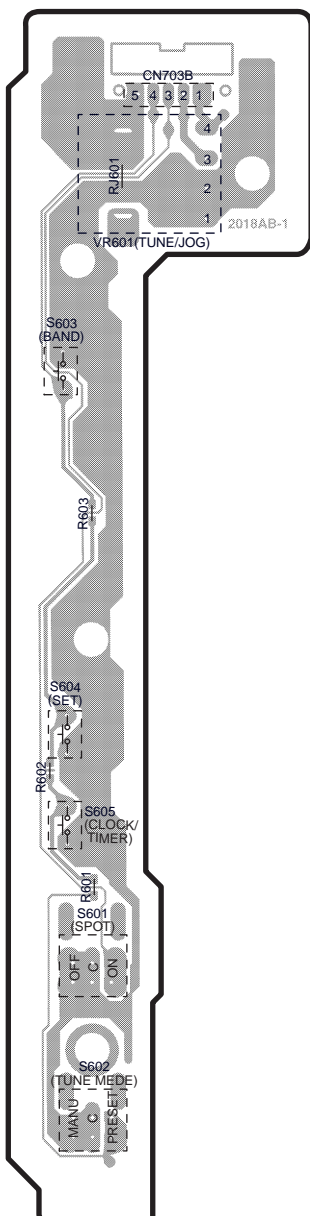

(REP2769G-S)

ELECTRICAL PARTS LOCATION

Ref. No.	Lo. No.	Ref. No.	Lo. No.
FL P.C.B.			
IC701	4B	R730	2B
Q701	5B	R733	5A
Q702	5A	R734	5A
Q791	2B	R735	7B
Q792	2B	R736	7B
D701	5B	R737	7B
D703	5C	R738	6B
D704	5B	R739	6B
D705	5C	R740	6B
D706	2B	R741	6B
D711	3B	R742	6B
D713	2A	R743	6A
D791	2B	R744	6A
L701	5B	R745	6B
L702	2B	R746	6B
L703	2B	R747	6B
L704	2B	R748	6B
L705	3C	R749	6B
L706	4C	R750	6B
L707	2B	R751	6B
Z701	6A	R752	6B
X701	5B	R753	6B
X702	5B	R754	6B
FL701	2A	R755	6B
CN701B	3C	R756	6B
CN702B	6C	R757	6B
CN703A	7B	R758	6B
W603A	2B	R759	6B
W604A	7B	R760	4C
R701	5B	R781	3B
R702	5B	R782	3A
R703	5B	R791	2B
R704	5B	R792	2B
R705	5B	RJ704	5B
R706	5C	RJ705	4C
R707	5C	C701	5B
R708	5C	C702	5B
R709	6B	C703	5B
R710	7A	C704	5B
R711	4B	C705	5B
R712	3B	C706	5B
R713	3B	C707	5B
R714	3B	C708	5C
R715	3B	C709	5C
R716	3B	C710	6B
R717	3B	C711	4B
R718	3B	C712	6A
R719	3B	C713	6A
R720	3B	C715	5B
R721	3B	C716	5B
R722	3B	C717	6B
R723	2B	C718	6B
R724	2B	C719	7B
R725	2B	C781	2A
R726	2B	C782	6A
R727	2B	C791	6A
R728	2B	C792	7B
R729	3B		
OPERATION P.C.B.			
VR601	2D	CN703B	2D
S601	6D	R601	6D
S602	7D	R602	5D
S603	3D	R603	4D
S604	5D	RJ601	2D
S605	5D		

MAIN P.C.B.

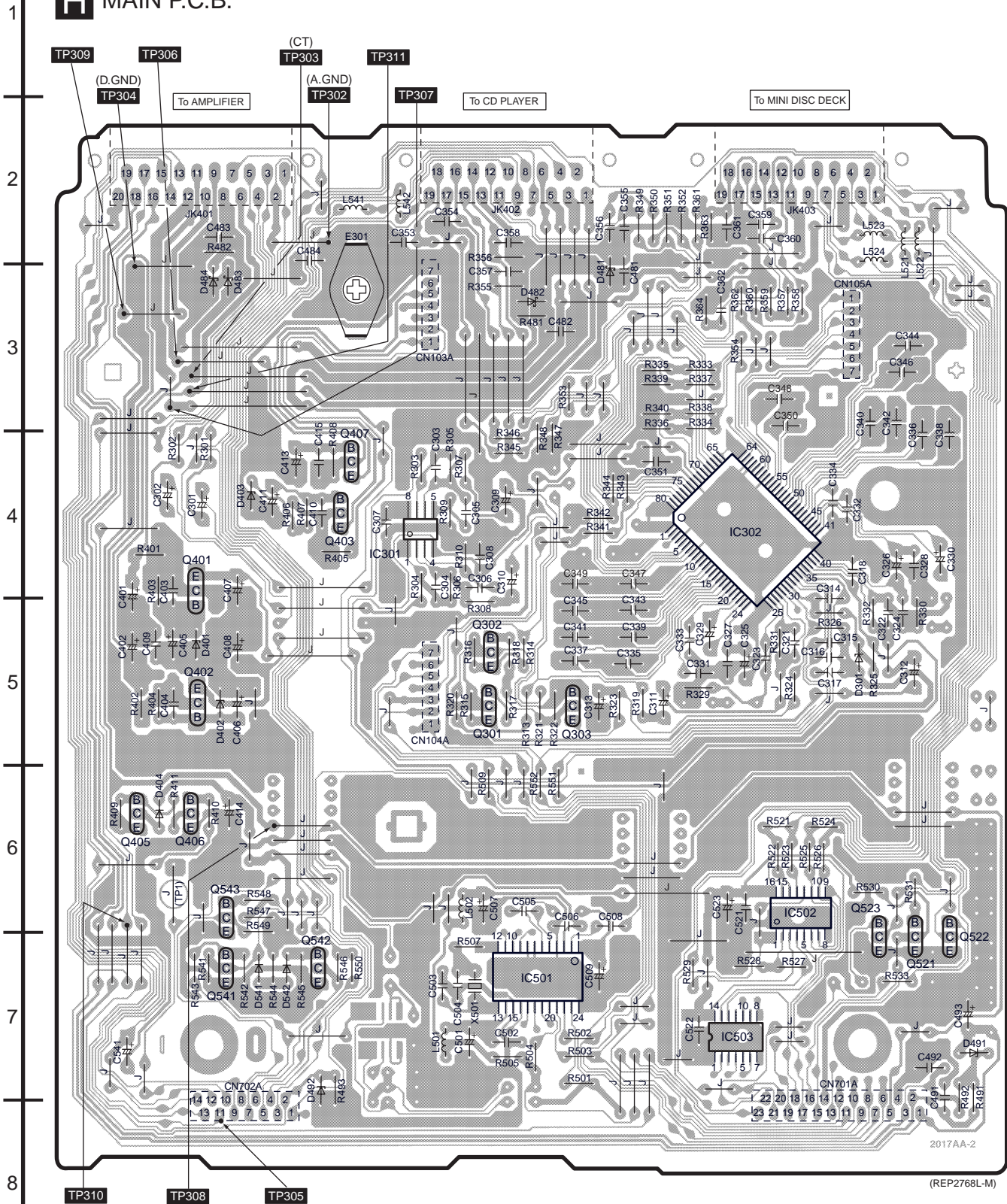

2017AA-2

(REP2768L-M)

G CONNECTOR P.C.B.

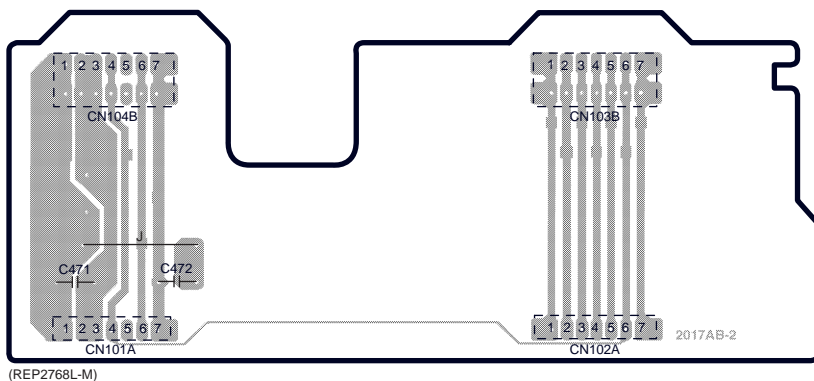

ELECTRICAL PARTS LOCATION

Ref. No.	Lo. No.	Ref. No.	Lo. No.	Ref. No.	Lo. No.	Ref. No.	Lo. No.	Ref. No.	Lo. No.	Ref. No.	Lo. No.
G CONNECTOR P.C.B.											
CN101A	3H	CN102A	3J	CN103B	2J	CN104B	2H	C471	2H	C472	2H
H MAIN P.C.B.											
IC301	4C	CN105A	3E	R331	5E	R411	6A	C308	4C	C355	2D
IC302	4E	CN701A	8E	R332	5F	R481	3D	C309	4C	C356	2D
IC501	7D	CN702A	8B	R333	3E	R482	2B	C310	4C	C357	3C
IC502	6E	JK401	2B	R334	3E	R491	7F	C311	5D	C358	2C
IC503	7E	JK402	2C	R335	3D	R492	7F	C312	5F	C359	2E
Q301	5C	JK403	2E	R336	3D	R493	7B	C313	5D	C360	2E
Q302	5C	E301	3C	R337	3E	R501	7D	C314	5E	C361	2E
Q303	5D	(TP1)	6A	R338	3E	R502	7D	C315	5E	C362	3E
Q401	4B	TP302	2B	R339	3D	R503	7D	C316	5E	C401	5A
Q402	5B	TP303	3B	R340	3D	R504	7D	C317	5E	C402	5A
Q403	4B	TP304	3A	R341	4D	R505	7C	C318	4E	C403	4A
Q405	6A	TP305	8B	R342	4D	R507	7C	C321	5E	C404	5A
Q406	6B	TP306	3A	R343	4D	R509	6C	C322	5F	C405	5A
Q407	4B	TP307	3A	R344	4D	R521	6E	C323	5E	C406	5B
Q521	7F	TP308	6B	R345	4C	R522	6E	C324	5F	C407	4B
Q522	7F	TP309	3A	R346	4C	R523	6E	C325	5E	C408	5B
Q523	7F	TP310	6A	R347	4D	R524	6E	C326	4F	C409	5A
Q541	7B	TP311	3B	R348	4D	R525	6E	C327	5E	C410	4B
Q542	7B	R301	4B	R349	2D	R526	6E	C328	4F	C411	4B
Q543	6B	R302	4A	R350	2D	R527	7E	C329	5E	C413	4B
D301	5F	R303	4C	R351	2D	R528	7E	C330	4F	C414	6B
D401	5B	R304	4C	R352	2D	R529	7D	C331	5E	C415	4B
D402	5B	R305	4C	R353	3D	R530	6F	C332	4E	C481	3D
D403	4B	R306	4C	R354	3E	R531	6F	C333	5D	C482	3D
D404	6A	R307	4C	R355	3C	R533	7F	C334	4E	C483	2B
D481	3D	R308	5C	R356	2C	R541	7B	C335	5D	C484	2B
D482	3D	R309	4C	R357	3E	R542	7B	C336	4F	C491	7F
D483	3B	R310	4C	R358	3E	R543	7B	C337	5D	C492	7F
D484	3B	R313	5D	R359	3E	R544	7B	C338	4F	C493	7F
D491	7F	R314	5D	R360	3E	R545	7B	C339	5D	C501	7C
D492	7B	R315	5C	R361	2E	R546	7B	C340	3F	C502	7C
D541	7B	R316	5C	R362	3E	R547	6B	C341	5D	C503	7C
D542	7B	R317	5C	R363	2E	R548	6B	C342	3F	C504	7C
L501	7C	R318	5C	R364	3E	R549	6B	C343	5D	C505	6D
L502	6C	R319	5D	R401	4A	R550	7B	C344	3F	C506	6D
L521	2F	R320	5C	R402	5A	R551	6D	C345	5D	C507	6C
L522	2F	R321	5D	R403	4A	R552	6D	C346	3F	C508	6D
L523	2F	R322	5D	R404	5A	C301	4B	C347	4D	C509	7D
L524	2F	R323	5D	R405	4B	C302	4A	C348	3E	C521	6E
L541	2B	R324	5E	R406	4B	C303	4C	C349	4D	C522	7E
L542	2C	R325	5F	R407	4B	C304	4C	C350	3E	C523	6E
X501	7C	R326	5E	R408	4B	C305	4C	C351	4D	C541	7A
CN103A	3C	R329	5E	R409	6A	C306	4C	C353	2C		
CN104A	5C	R330	5F	R410	6B	C307	4C	C354	2C		